

# KOMATSU

## PC16R-3



Mini-excavator

**Engine power**  
11.6 kW / 15.6 HP @ 2600 rpm

**Operating weight**  
1740 - 1810 kg

**Bucket capacity**  
0.03 - 0.06 m<sup>3</sup>

## PC16R-3



Engine power  
**11.6 kW / 15.6 HP @ 2600 rpm**

Operating weight  
**1740 - 1810 kg**

Bucket capacity  
**0.03 - 0.06 m<sup>3</sup>**

# High versatility, low fuel consumption and **safe performance in tight spaces**

## **Complete versatility**

- Standard 1- or 2-way auxiliary line for attachments
- Numerous configurations available
- Ideal for a wide range of applications

## **Outstanding performance**

- Low consumption EU Stage V engine
- Optimal power and digging speed in confined spaces
- Perfect control even during combined operations
- Fast and precise movements

## **Highest operator comfort**

- Spacious working environment ensures outstanding comfort
- Excellent accessibility to and from the machine
- Pressure Proportional Control (PPC) servo-controls

## **Easy serviceability**

- Easy access to all daily inspection points
- Tilting canopy provides access for larger maintenance jobs
- Extended 500-hour service interval

## **Extremely robust**

- Excellent stability and safety for maximum operator confidence in any conditions
- High quality standards guarantee longer lifetime for all components
- ROPS and OPG compliant canopy

## **Komtrax (option)**

- Komatsu Wireless Monitoring System
- 4G mobile communications
- Increased operational data for better fleet management



# Outstanding performance

### Outstanding performance

The easy-to-use PC16R-3 allows all operators to get the best from their machine – whether they are experts or novices. The controls are user-friendly and dedicated to each movement. Smooth operations, enhanced by the CLSS hydraulic system, in combination with perfect visibility of the working area guarantee maximum productivity in even the toughest situations.



## Highest operator comfort



### Highest operator comfort

Designed with the utmost attention to detail, the operator's environment ensures outstanding comfort, accessibility and visibility. The canopy allows easy access to and from the machine. Once seated, the spacious, obstacle-free floor allows even the tallest operators room to move their legs.

For even greater comfort, an adjustable seat and PPC controls are fitted as standard.



The two-speed tracking is operated via a switch on the dashboard. The dashboard also allows the operator to monitor all machine functions.

## Extremely robust



### Extremely robust

A number of particular technical solutions contribute to the PC16R-3's increased sturdiness and operability. These include a cast swing support that makes the structure extremely rigid, and a boom that houses the hydraulic hoses, protecting them from possible damage and guaranteeing the best visibility of the digging area. Furthermore, the choice of metal for the bonnets and covers guarantees a longer life and lower repair costs in case of collision.



## Complete versatility



### Customisation

With many configurations available, you can choose exactly the right machine for a specific job: long or short arm, rubber or steel shoes. Moreover, the 1- / 2-way auxiliary hydraulic circuit allows the use of a wide range of working tools like a hammer, clamshell bucket, auger etc.

### Variable undercarriage

For applications requiring maximum versatility in terms of size and stability, the PC16R-3 is available with hydraulic undercarriage extension, which is operated from the operator's seat via a push button and the blade control lever. This feature allows the operator to quickly switch from maximum stability for working to a reduced width of less than one metre for driving through narrow passages or doors.



## Easy serviceability



### Easy serviceability

All periodic inspection points are easily accessible through the machine's bonnets. In addition, larger maintenance tasks can be performed by simply tilting the canopy upwards.

ORFS hydraulic face seal connectors and DT electrical connectors enhance the machine's reliability and makes repairs faster and easier. Special technical solutions have allowed the interval for most ordinary maintenance operations, such as pin greasing and engine oil changes, to be extended to up to 500 hours.



Right bonnet: simple inspection and cleaning of the radiators



Rear bonnet: quick engine check and fuel tank refilling



Left bonnet: easy access to the battery refilling



## Information & communication technology



### Knowledge

You get quick answers to basic and critical questions about your machines – what they're doing, when they did it, where they're located, how they can be used more efficiently and when they need to be serviced. Performance data is relayed by wireless communication technology (satellite, GPRS or 4G depending on model) from the machine to a computer and to the local Komatsu distributor – who's readily available for expert analysis and feedback.

### Convenience

Komtrax enables convenient fleet management on the web, wherever you are. Data is analysed and packaged specifically for effortless and intuitive viewing in maps, lists, graphs and charts. You can foresee eventual maintenance issues and required spare parts, and troubleshoot a problem before Komatsu technicians arrive on site.



### The way to higher productivity

Komtrax uses the latest wireless monitoring technology. Compatible on PC, smartphone or tablet, it delivers insightful and cost saving information about your fleet and equipment, and offers a wealth of information to facilitate peak machine performance. By creating a tightly integrated web of support it allows proactive and preventive maintenance and helps to efficiently run a business.

### Power

The detailed information that Komtrax puts at your fingertips 24 hours a day, 7 days a week gives the power to make better daily and long-term strategic decisions – at no extra cost. Problems can be anticipated, maintenance schedules customised, downtime minimised and machines kept where they belong: working on the jobsite.



# Specifications

## Engine

Model	Komatsu 3D67E-2A
Type	Emissionised 4-cycle diesel engine
Engine power	
at rated engine speed	2600 rpm
ISO 14396	11.6 kW / 15.6 HP
ISO 9249 (net engine power)	11.2 kW / 15.0 HP
Displacement	778 cm <sup>3</sup>
No. of cylinders	3
Max. torque / engine speed	44.1 Nm / 1800 rpm
Cooling system	Water
Air filter type	Dry
Starter motor	Electric motor with pre-heating air system for cold climate

## Operating weight (appr.)

Operating weight with rubber shoes	1740 kg
Operating weight with steel shoes	1810 kg

Operating weight with standard bucket, variable undercarriage, fully serviced, +75 kg operator (ISO 6016).

## Hydraulic system

Type	Komatsu CLSS
Main pumps	1 × variable displacement pump
Max. pump flow	40.8 l/min
Max. operating pressure	21 MPa (210 bar)
Bucket digging force	1150 kg
Arm crowd force (ISO 6015)	
965 mm arm	900 daN (920 kg)
1215 mm arm	715 daN (730 kg)

The digging equipment is fully controlled by PPC servo-controls. All movements are stopped by lifting the safety lever on the tilting case.

## Transmission

Type	Double speed hydrostatic transmission, controlled and steered by means of two levers or two pedals
Hydraulic motors	2 × axial piston motor
Reduction system	Planetary gear
Maximum drawbar pull	1490 daN (1520 kgf)
Max. travel speeds (Lo / Hi)	2.2 - 4.2 km/h

## Swing system

The rotation is operated by means of an orbital hydraulic motor. Single ball-bearing ring with internal, induction hardened toothring. Centralised lubrication of the unit.

Swing speed	8.9 rpm
-------------	---------

## Blade

Type	Electro-welded, single unit structure
Width × height	1020 × 250 mm
Max. lifting above ground level	280 mm
Max. depth below ground level	155 mm

## Undercarriage

Track rollers (each side)	3
Shoe width	230 mm
Ground pressure (standard)	0.3 kg/cm <sup>2</sup>

## Service refill capacities

Fuel tank	19 l
Cooling system	3.1 l
Engine oil (refill)	3.3 l
Hydraulic system (refill)	1.2 l

## Environment

Engine emissions	Fully complies with EU Stage V exhaust emission regulations
Noise levels	
LwA external	93 dB(A) (2000/14/EC Stage II)
LpA operator ear	77 dB(A) (ISO 6396 dynamic test)
Vibration levels (EN 12096:1997)	
Hand/arm	≤ 2.5 m/s <sup>2</sup> (uncertainty K = 1.2 m/s <sup>2</sup> )
Body	≤ 0.5 m/s <sup>2</sup> (uncertainty K = 0.2 m/s <sup>2</sup> )

## Bucket range

Width mm	Capacity m <sup>3</sup> (ISO 7451)	Weight kg	No. of teeth
250	0,03	19	2
300	0,035	20	3
350	0,04	22	3
400	0,05	23	3
450	0,06	25	4

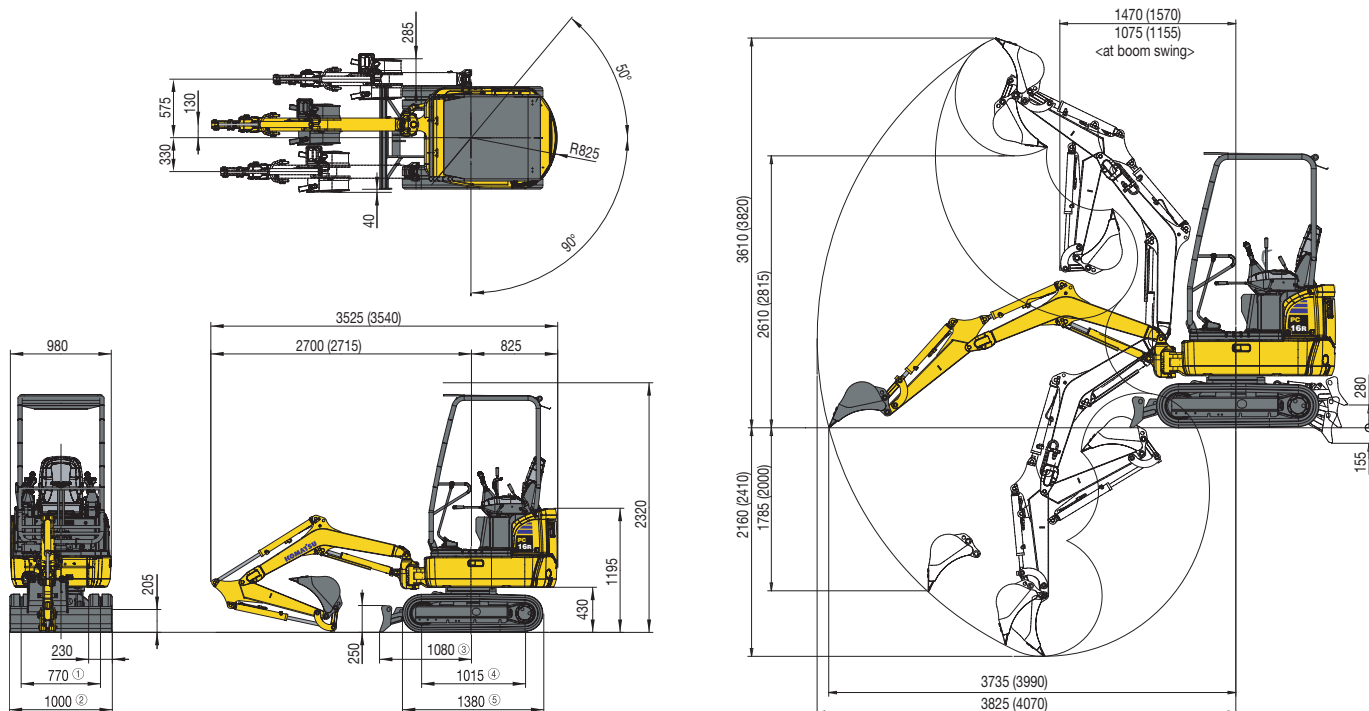

HS version:

- |                  |            |
|------------------|------------|
| 1. 750 - 1070 mm | 3. 1145 mm |
| 2. 980 - 1300 mm | 4. 1212 mm |
|                  | 5. 1555 mm |

## Lifting capacity with rubber shoes, blade up

**A** Reach from swing centre

**B** Bucket hook height









 Rating over front

 Undercarriage retracted

 Rating over side

 Undercarriage extended

Lifting capacities without bucket

Arm length	A	Max.		3.0 m			2.0 m				
		B									
965 mm	3.0 m	kg	*390					*390	*380	*380	
	2.0 m	kg	*355	200	290			*305	*350	*350	
	1.0 m	kg	275	180	255	310	210	290	*590	350	*595
	0.0 m	kg	280	180	270	305	195	290		320	485
	-1.0 m	kg	*410	235	335					325	480
1215 mm	3.0 m	kg	*315	*310	*320						
	2.0 m	kg	*310	170	255	*300	195	*305	*280	*280	*290
	1.0 m	kg	245	150	220	300	190	275	*510	335	*525
	0.0 m	kg	240	165	235		195	275	340	345	500
	-1.0 m	kg					205	300	340	340	470

NOTE:

Ratings are based on ISO standard 10567. Rated loads do not exceed 87% of hydraulic lift capacity or 75% of tipping load.

- The values marked with an asterisk (\*) are limited by the hydraulic capacities.

- Calculations are based on the machine resting on a uniform and firm surface.

- The lifting point is a hypothetical hook placed behind the bucket.

# Standard and optional equipment

## Engine

Komatsu 3D67E-2A diesel engine	●
EU Stage V compliant	●
Two speeds with "Automatic Shift Down"	●
Alternator 12 V / 40 A	●
Starter motor 12 V / 1.2 kW	●
Batteries 12 V / 41 Ah	●

## Hydraulic system

Komatsu closed-centre load sensing (CLSS) hydraulic system	●
1 / 2 way auxiliary hydraulic circuit for attachments up to the boom	●
Safety valve on bucket element	●
Extension of the auxiliary hydraulic circuit up to the arm, with quick couplings	○
Travel pedals	○

## Undercarriage

Rubber shoes	●
Variable undercarriage	●
Steel shoes	○

## LED lighting system

Working light on boom	●
Rotating beacon	○

## Service and maintenance

Komtrax – Komatsu wireless monitoring system (4G)	○
---	---

## Canopy

ROPS (ISO 3471) - OPG (ISO 10262) level 1 canopy	●
Adjustable seat	●

## Safety equipment

Lifting cylinder guard	●
Audible travel alarm	●
Mountings for OPG Level 1 front guard	●
Rear-view mirrors	○

## Work equipment

965 mm digging arm	●
1215 mm digging arm	●
Bucket range (250 - 450 mm)	○
1000 mm ditch cleaning bucket	○

## Other equipment

Biodegradable oil for hydraulic system	○
--	---

Further equipment on request

- standard equipment
- optional equipment

This specification sheet may contain attachments and optional equipment that are not available in your area. Please consult your local Komatsu distributor for those items you may require.

Materials and specifications are subject to change without notice.

Your Komatsu partner:

# KOMATSU

komatsu.eu

